

### Wireless Bluetooth to Analog Module (compatible with WEPS04/WETS02/WEPS36/WEHS02)



- Monitor up to 4 sensors (Pressure, Temperature, Humidity)
- Converts BLE signal to Analog Output (0-5V)
- 0 to 5 Output Volt Scale
- 9 to 24 Input Voltage
- Up to 300 Feet away (LOS)
- Uses Bluetooth Low Energy Version 4.2

#### DESCRIPTION

The WEXS-BLE-AN is a Bluetooth gateway that can connect up to four Wireless Phoenix Sensors. Including Pressure, Temperature, Humidity, or Position sensors. This gateway uses the Bluetooth Low Energy 5.0 protocol for communication. The wireless range can be as high as 300 feet with Line of Site.

The WEXS-BLE-AN provides an analog output for each sensors pressure/temperature reading. The analog output can be utilized as an input into a PLC (Programmable Logic Controller) or PC for automation or data collection. The analog output is 0 to 5 volts. Example, 100 PSI WEPS04 (Wireless Pressure Transducer) connected to WEXS-BLE-AN, and it's reading is 50 PSI, the corresponding output voltage would be 2.5V. The input voltage for this Bluetooth gateway is 9 to 24V. Now, it is easier than ever to read data from up to four of our Wireless Phoenix Sensors!

#### APPLICATIONS

- Industrial PLC (Programmable Logic Controllers)
- Simultaneous Data Between Wireless Sensors
- Monitoring Refrigeration Units, Wine Cellars
- Hydraulic Press Data Readings
- Multi-stage Water Pumps
- Commercial HVAC – Air Conditioning Units
- Air Compressors

### WEPS04 Maximum Environmental Ratings

Operating Temperature ..... -20°C to 85°C  
Storage Temperature Range ..... -40°C to 85°C

Proof pressure ..... 2x full scale pressure  
Burst pressure ..... 3x full scale pressure (Max 12kPSI)

## Pressure Readings – Monitor up to 4 Wireless Sensors (WEPS04/WETS02/WEHS02/WEPS36)



### HVAC – High & Low Side of A/C



The WEXS-BLE-AN is a Bluetooth Gateway for the WEPS04 that can measure up to pressures of 5,000 PSI. It is accurate and robust enough for HVAC applications; if you need temporary remote Pressure and Temperature measurement of the system this sensor is your solution.

### Air Compressors

The WEXS-BLE-AN is a Bluetooth Gateway for the WEPS04 that can measure up to pressures of 5,000 PSI, so it is ideal for most air compressor applications. For troubleshooting, the WEXS-BLE-AN offers temporary remote Pressure and Temperature measurement of the system. The battery powered solution can last up to 12-months of continuous (1 measurement/10 seconds) use.



### Pumps – Water, Hydraulic, etc.



The WEXS-BLE-AN is a Bluetooth Gateway for the WEPS04 that can measure up to pressures of 5,000 PSI, so it is ideal for Pump applications. For monitoring, the WEXS-BLE-AN offers temporary remote Pressure measurement of the system. The battery powered solution can last up to 18-months of continuous (1 measurement/30 seconds) use.

## WEXS-BLE-AN Getting Started Instructions

1) “Home” Page (Fig 1)– Click on “Select Device” to see the list of devices. Then, click on the name that starts with ANA1:XX:XX to connect with a WEXS-BLE-AN Gateway.

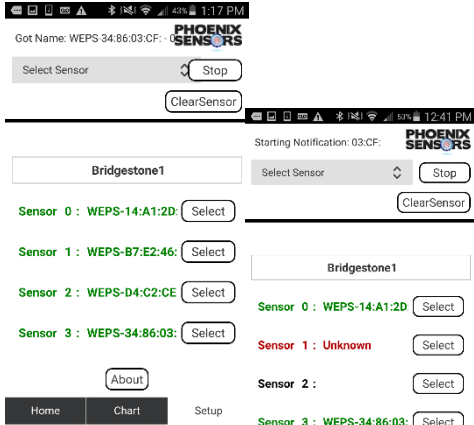

Fig 2

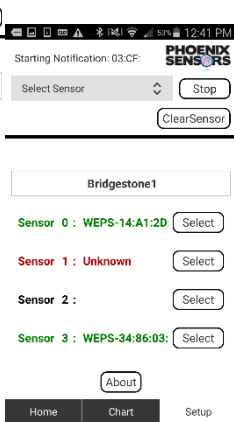

Fig 3

2) Go to “Setup” Page (Fig 2)– Click on “Select Device” to see the list of devices. Click on any sensor that starts with “WEPS:XX:XX” or “WETS:XX:XX, then click “Select” next to the desired “Sensor X” you would like to connect to. You will need to wait ~5-15 seconds to connect completed. The Sensor will be **RED & say Unknown** (Fig 3) while it is connecting to the sensor.

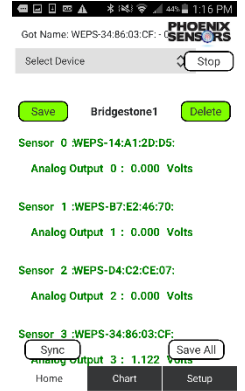

Fig 1



Fig 4

3) Go to “Home” Page (Fig 4)– See Real Time Data streaming. The Analog Output will display corresponding to the pressure value. NOTE: The pressure value cannot be displayed, you will need to know the Pressure range of the sensor to calculate pressure.

4) Go to “Chart” Page (Fig 5)– See Real Time Data streaming on Time vs Voltage Graph. The Analog Output will display via a color code to the corresponding to the pressure value. NOTE: The pressure value cannot be displayed, you will need to know the Pressure range of the sensor to calculate pressure.

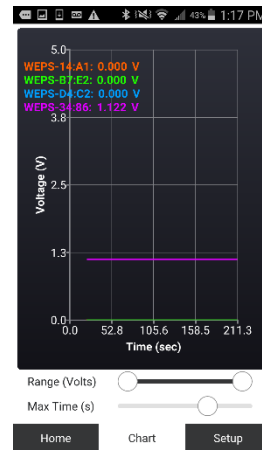

Fig 5

# WEXS-BLE-AN Operational Characteristics

$V_+ = 5V$ , $V_- = 0V$ , Temperature = 25°C				
PARAMETER	SYMBOL	MIN	MAX	UNITS
Maximum Sensors		1	4	
Wireless Sensor Compatibility		WEPS04, WETS02, WEH01		Wireless
Input Voltage	V	9	24	Volts
Wireless Digital Output (BLE)	BLE v4.2			
Outputs (A1 – A4)	V	0	5	Volts
Output Current Draw (for ALL four Output)	V		80	mA
Current Draw	mA	20	35	Milliamps
Environmental Rating		IP50		
BLE Wireless Range	Ft	10	125	Feet

## Application Information

### Package

While our WEXS-BLE-AN is made out of plastic and is only IP50 withstand the elements, the WEPS04 offers two piece sensor body design made of SS316, which allows for easy low-cost manufacturability and corrosion resistance. The WEPS04/WETS02 designs are IP65/67, and Vibration proof designs for use in industrial applications. Plastic option is available for custom designs

### Distance

The WEXS-BLE-AN can reach WEPS04 from up to 125 feet away with a clear Line of Site (LOS). This ensures you will have enough distance between your sensors and your gateway with no worries. The data will be converted into an analog output and sent to your mobile phone via our Mobile BLE application. You can use the Analog output as an input into a PLC (Programmable Logic Controller) or PC for control feedback.

### Pressure port

The WEPS04/WETS02 that connects to this gateway offer 1/4" -18NPT and 1/8"-18NPT threads are standard SS fittings. Other port fittings such as 7/16-20UNF, and 1/4" BSP are available for OEM customers.

### Media

The WEPS04/WETS02 media ports are tolerant to most media including but not limited to oil, air, gas, and any media compatible with 17-4PH, Brass, or 316L. We do have other material options such as Inconel and Titanium for OEM customers.

### Wetted parts

When checking media capability for the WEPS04/WETS02, the wetted surface is composed of Stainless Steel (316L or 17-4PH). The WEXS-BLE-AN does not feature an IP65 or IP67 option at this time.

## Electrical Connections

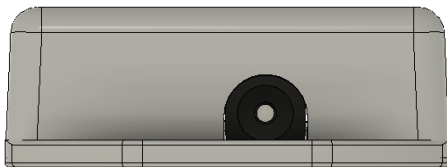

Input Voltage- 9-24V

2.5mm X 5mm Jack



**A1 A2 A3 A4**

- + - +

## Mechanical Dimensions (mm)

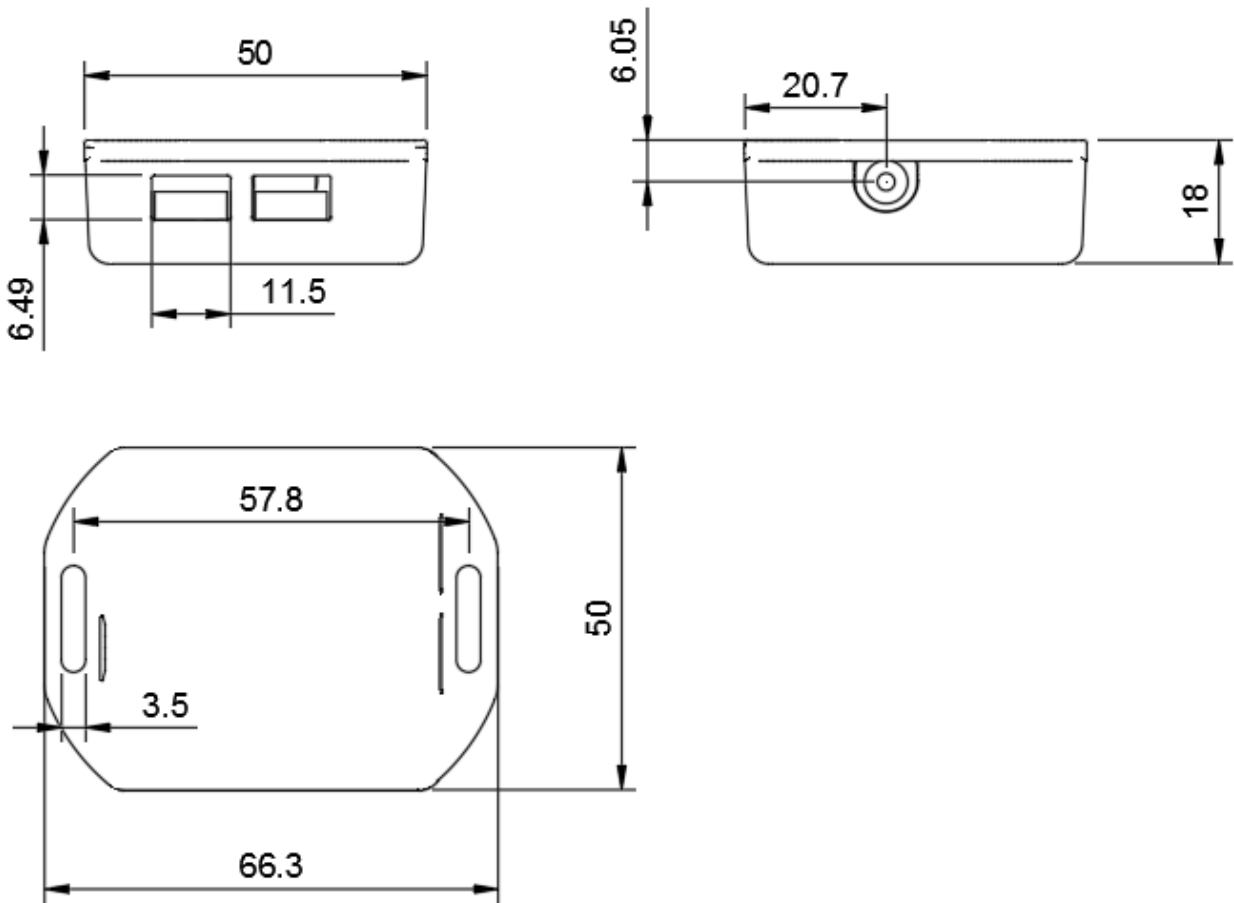

## Part Number Configuration

**WEXS-BLE-AN**

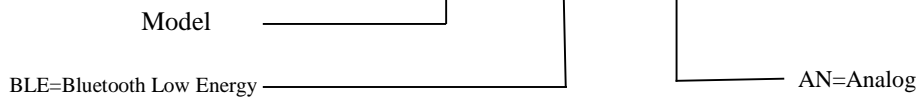

Ph: (480) 462-1810 [sales@PhoenixSensors.com](mailto:sales@PhoenixSensors.com)

### Notice:

Phoenix Sensors LLC reserves the right to make changes to the product contained in this publication. Phoenix Sensors LLC assumes no responsibility for the use of any circuits described herein, conveys no license under any patent or other right, and makes no representation that the circuits are free of patent infringement. While the information in this publication has been checked, no responsibility, however, is assumed for inaccuracies.

Phoenix Sensors LLC does not recommend the use of any of its products in life support applications where the failure or malfunction of the product can reasonably be expected to cause failure of a life-support system or to significantly affect its safety or effectiveness. Products are not authorized for use in such applications.